



Vehicle History Report™

US \$39.99

2003 MERCEDES-BENZ G500

VIN: WDCYR49E83X135991
4 DOOR WAGON/SPORT UTILITY
5.0L V8 F SOHC 24V GASOLINE
ALL WHEEL DRIVE



39 Service history records

5 Previous owners

Types of owners: Personal lease, Personal

143,093 Last reported odometer reading

This CARFAX Vehicle History Report is based only on information supplied to CARFAX and available as of 12/13/22 at 1:49:13 PM (CST). Other information about this vehicle, including problems, may not have been reported to CARFAX. Use this report as one important tool, along with a vehicle inspection and test drive, to make a better decision about your next used car.

| Ownership History The number of owners is estimated | Owners 1-3 | Owner 4 | Owner 5 |
|---|-------------|--------------|-------------------|
| Year purchased | 2002 | 2017 | 2021 |
| Type of owner | See Details | Personal | Personal |
| Estimated length of ownership | 15 years | 2 yrs. 9 mo. | 1 day |
| Owned in the following states/provinces | See Details | California | Oklahoma, Florida |
| Estimated miles driven per year | See Details | 6,361/yr | --- |
| Last reported odometer reading | 125,119 | 143,093 | --- |

| Title History CARFAX guarantees the information in this section | Owners 1-3 | Owner 4 | Owner 5 |
|--|---------------------------------|---------------------------------|---------------------------------|
| Damage Brands Salvage Junk Rebuilt Fire Flood Hail Lemon | Guaranteed No Problem | Guaranteed No Problem | Guaranteed No Problem |

| | | | |
|--|---|---|---|
| Odometer Brands Not Actual Mileage Exceeds Mechanical Limits | <input checked="" type="checkbox"/> Guaranteed No Problem | <input checked="" type="checkbox"/> Guaranteed No Problem | <input checked="" type="checkbox"/> Guaranteed No Problem |
|--|---|---|---|







GUARANTEED - None of these major title problems were reported by a state Department of Motor Vehicles (DMV). If you find that any of these title problems were reported by a DMV

| CARFAX Additional History Not all accidents / issues are reported to CARFAX | Owners 1-3 | Owner 4 | Owner 5 |
|--|---|---|---|
| Total Loss No total loss reported to CARFAX. | <input checked="" type="checkbox"/> No Issues Reported | <input checked="" type="checkbox"/> No Issues Reported | <input checked="" type="checkbox"/> No Issues Reported |
| Structural Damage CARFAX recommends that you have this vehicle inspected by a collision repair specialist. | <input checked="" type="checkbox"/> No Issues Reported | <input checked="" type="checkbox"/> No Issues Reported | <input checked="" type="checkbox"/> No Issues Reported |
| Airbag Deployment No airbag deployment reported to CARFAX. | <input checked="" type="checkbox"/> No Issues Reported | <input checked="" type="checkbox"/> No Issues Reported | <input checked="" type="checkbox"/> No Issues Reported |
| Odometer Check No indication of an odometer rollback. | <input checked="" type="checkbox"/> No Issues Indicated | <input checked="" type="checkbox"/> No Issues Indicated | <input checked="" type="checkbox"/> No Issues Indicated |
| Accident / Damage Damage reported: 01/10/2018 and 12/20/2019. | <input checked="" type="checkbox"/> No Issues Reported | Minor Damage | No New Issues Reported |
| Manufacturer Recall Check with an authorized Mercedes-Benz dealer for any open recalls. | <input checked="" type="checkbox"/> No Recalls Reported | <input checked="" type="checkbox"/> No Recalls Reported | <input checked="" type="checkbox"/> No Recalls Reported |

CARFAX Detailed History

| | | | |
|--------------------------------------|--|---|---------------------------------------|
| Owner 1 Purchased: 2002 | | Low mileage! This owner drove less than the industry average of 15,000 miles per year. | Personal Lease Vehicle 9,355 mi/yr |
|--------------------------------------|--|---|---------------------------------------|

| Date | Mileage | Source | Comments |
|------|---------|--------|----------|
|------|---------|--------|----------|

| | | | |
|---|--|---|--|
| 10/28/2002 | Mercedes-Benz of Stevens Creek San Jose, CA 408-641-4610 |  | Vehicle serviced Pre-delivery inspection completed Accessories installed Vehicle washed/detailed |
| <p>★ 4.4 / 5.0 226 Verified Reviews ♥ 47 Customer ♥ 1 Favorites</p> | | | |
| 10/30/2002 8 | California Motor Vehicle Dept. San Jose, CA | Title issued or updated First owner reported Titled or registered as personal lease vehicle Loan or lien reported | |
| 12/09/2002 | Mercedes-Benz of Stevens Creek San Jose, CA 408-641-4610 |  | Vehicle serviced Accessories installed Window(s) checked Doors checked Oil and filter changed |
| <p>★ 4.4 / 5.0 226 Verified Reviews ♥ 47 Customer ♥ 1 Favorites</p> | | | |
| 01/16/2003 | Mercedes-Benz of Stevens Creek San Jose, CA 408-641-4610 |  | Vehicle serviced Doors checked Interior trim checked Oil and filter changed Window(s) checked |
| <p>★ 4.4 / 5.0 226 Verified Reviews ♥ 47 Customer ♥ 1 Favorites</p> | | | |
| 02/24/2003 | Mercedes-Benz of Stevens Creek San Jose, CA 408-641-4610 |  | Vehicle serviced Oil and filter changed Doors checked |
| <p>★ 4.4 / 5.0</p> | | | |

★ 4.4 / 5.0
226 Verified Reviews
♥ 47 Customer
1 Favorites

03/17/2003

Mercedes-Benz of
Stevens Creek
San Jose, CA
408-641-4610

Vehicle serviced

★ 4.4 / 5.0
226 Verified Reviews
♥ 47 Customer
1 Favorites

04/02/2003

Mercedes-Benz of
Stevens Creek
San Jose, CA
408-641-4610

Vehicle serviced

★ 4.4 / 5.0
226 Verified Reviews
♥ 47 Customer
1 Favorites

08/01/2003

California
Motor Vehicle Dept.
San Jose, CA

Title issued or updated
Loan or lien reported

11/20/2003

Mercedes-Benz of
Stevens Creek
San Jose, CA
408-641-4610

Vehicle serviced
Oil and filter changed
Window(s) checked

★ 4.4 / 5.0
226 Verified Reviews
♥ 47 Customer
1 Favorites

12/04/2003

Mercedes-Benz of
Stevens Creek
San Jose, CA
408-641-4610

Vehicle serviced
Oil and filter changed
Doors checked

★ 4.4 / 5.0
226 Verified Reviews
♥ 47 Customer
1 Favorites

01/19/2004

Mercedes-Benz of
Stevens Creek
San Jose, CA
408-641-4610

Vehicle serviced
Oil and filter changed
Steering/suspension checked

★ 4.4 / 5.0
226 Verified Reviews
♥ 47 Customer
1 Favorites

01/31/2004

Mercedes-Benz of

Vehicle serviced

| | | |
|------------|---|--|
| | <p>Stevens Creek San Jose, CA 408-641-4610</p> <p>★ 4.4 / 5.0 226 Verified Reviews ♥ 47 Customer 1 Favorites</p> | <p>Oil and filter changed Steering/suspension checked</p> |
| 03/17/2004 | <p>Mercedes-Benz of Stevens Creek San Jose, CA 408-641-4610</p> <p>★ 4.4 / 5.0 226 Verified Reviews ♥ 47 Customer 1 Favorites</p> | <p>Vehicle serviced</p> |
| 03/26/2004 | <p>Mercedes-Benz of Stevens Creek San Jose, CA 408-641-4610</p> <p>★ 4.4 / 5.0 226 Verified Reviews ♥ 47 Customer 1 Favorites</p> | <p>Vehicle serviced Door locks checked Oil and filter changed Doors checked</p> |
| 04/22/2004 | <p>Mercedes-Benz of Stevens Creek San Jose, CA 408-641-4610</p> <p>★ 4.4 / 5.0 226 Verified Reviews ♥ 47 Customer 1 Favorites</p> | <p>Vehicle serviced</p> |
| 07/23/2004 | <p>Mercedes-Benz of Stevens Creek San Jose, CA 408-641-4610</p> <p>★ 4.4 / 5.0 226 Verified Reviews ♥ 47 Customer 1 Favorites</p> | <p>Vehicle serviced Airbag system checked Interior trim checked Transmission checked Oil and filter changed</p> |
| 09/30/2004 | <p>Mercedes-Benz of Stevens Creek San Jose, CA 408-641-4610</p> <p>★ 4.4 / 5.0 226 Verified Reviews ♥ 47 Customer 1 Favorites</p> | <p>Vehicle serviced Oil and filter changed Interior trim checked</p> |
| 10/18/2004 | <p>Mercedes-Benz of</p> | <p>Vehicle serviced</p> |

| | | |
|------------|---|--|
| | <p>Stevens Creek San Jose, CA 408-641-4610</p> <p>★ 4.4 / 5.0 226 Verified Reviews ♥ 47 Customer 1 Favorites</p> | Oil and filter changed |
| 02/01/2005 | <p>Mercedes-Benz of Stevens Creek San Jose, CA 408-641-4610</p> <p>★ 4.4 / 5.0 226 Verified Reviews ♥ 47 Customer 1 Favorites</p> | <p>Vehicle serviced Engine checked Oil and filter changed Brake fluid flushed/changed</p> |
| 08/02/2005 | <p>Mercedes-Benz of Stevens Creek San Jose, CA 408-641-4610</p> <p>★ 4.4 / 5.0 226 Verified Reviews ♥ 47 Customer 1 Favorites</p> | <p>Vehicle serviced Window(s) checked Oil and filter changed Transmission checked</p> |
| 09/15/2005 | <p>Mercedes-Benz of Stevens Creek San Jose, CA 408-641-4610</p> <p>★ 4.4 / 5.0 226 Verified Reviews ♥ 47 Customer 1 Favorites</p> | <p>Vehicle serviced Window(s) checked Vehicle washed/detailed Oil and filter changed</p> |
| 01/03/2006 | <p>Mercedes-Benz of Stevens Creek San Jose, CA 408-641-4610</p> <p>★ 4.4 / 5.0 226 Verified Reviews ♥ 47 Customer 1 Favorites</p> | <p>Vehicle serviced Tire(s) balanced Four tires mounted Tire(s) mounted</p> |
| 05/26/2006 | <p>Mercedes-Benz of Stevens Creek San Jose, CA 408-641-4610</p> <p>★ 4.4 / 5.0 226 Verified Reviews ♥ 47 Customer 1 Favorites</p> | <p>Vehicle serviced Vehicle washed/detailed Battery/charging system checked Window(s) checked</p> |
| 08/05/2006 | 35,250 Dealer Inventory | Vehicle offered for sale |

08/08/2006

Mercedes-Benz of
Stevens Creek
San Jose, CA
408-641-4610

★ 4.4 / 5.0
226 Verified Reviews
♥ 47 Customer
1 Favorites

Vehicle serviced

Interior trim checked
Vehicle washed/detailed
Window(s) checked

08/10/2006 35,749

Mercedes-Benz Certified
Pre-Owned Dealer

**Offered for sale as a Mercedes-Benz
Certified Pre-Owned Vehicle**

Deuter Silver Exterior

Owner 2
Purchased:
2006



Low mileage! This owner drove less
than the industry average of 15,000
miles per year.

Personal Vehicle
8,904 mi/yr

Date

Mileage





Source











Comments



Stevens Creek
San Jose, CA
408-641-4610



★ 4.4 / 5.0
226 Verified Reviews
♥ 47 Customer
1 Favorites

Recommended maintenance
performed
Ashtray replaced
Two wheel alignment performed
Brakes checked
Electrical system checked
Interior trim checked
Accessories installed
Vehicle washed/detailed

| | | | |
|------------|--------|--|---|
| 10/01/2006 | 35,778 | California Motor Vehicle Dept. San Jose, CA | Title issued or updated New owner reported Loan or lien reported |
| 12/01/2006 | | California Motor Vehicle Dept. San Jose, CA | Title issued or updated Loan or lien reported Registration updated when owner moved the vehicle to a new location |
| 05/21/2007 | 41,584 | Mercedes-Benz of Stevens Creek San Jose, CA 408-641-4610 ★ 4.4 / 5.0 226 Verified Reviews ♥ 47 Customer 1 Favorites |  Vehicle serviced Recommended maintenance performed Maintenance inspection completed Vehicle washed/detailed Instrument cluster checked Shift motor replaced Computer(s) checked Alternator replaced |
| 03/04/2008 | 52,380 | Mercedes-Benz of Stevens Creek San Jose, CA 408-641-4610 ★ 4.4 / 5.0 226 Verified Reviews ♥ 47 Customer 1 Favorites |  Vehicle serviced Recommended maintenance performed Brake fluid flushed/changed Fuel filter replaced Four wheel alignment performed Antifreeze/coolant flushed/changed Spark plug(s) replaced Air filter replaced Tire(s) balanced Tires rotated Automatic transmission serviced Vehicle washed/detailed Induction system serviced Power steering fluid flushed/changed |
| 06/23/2008 | 57,669 | Mercedes-Benz of Stevens Creek San Jose, CA 408-641-4610 ★ 4.4 / 5.0 226 Verified Reviews ♥ 47 Customer 1 Favorites |  Vehicle serviced Maintenance inspection completed Recommended maintenance performed A/C and heating control assembly checked Vehicle washed/detailed Fuel system checked Shift motor replaced Brake light switch replaced Computer reprogrammed Computer(s) checked |
| 10/13/2008 | 61,615 | Mercedes-Benz of Stevens Creek San Jose, CA 408-641-4610 ★ 4.4 / 5.0 226 Verified Reviews |  Vehicle serviced Recommended maintenance performed Maintenance inspection completed Pinion seal(s) replaced Tire condition and pressure checked |

| | | | |
|------------|--------|---|---|
| | |  47 Customer  1 Favorites | Brakes checked Vehicle washed/detailed |
| 02/20/2009 | 66,578 | Mercedes-Benz of Stevens Creek San Jose, CA 408-641-4610  4.4 / 5.0 226 Verified Reviews  47 Customer  1 Favorites | Vehicle serviced Recommended maintenance performed Tire(s) balanced Tires rotated Vehicle washed/detailed A/C and heating control assembly checked Rear brake rotor(s) replaced |
| 09/15/2009 | 72,716 | Mercedes-Benz of Stevens Creek San Jose, CA 408-641-4610  4.4 / 5.0 226 Verified Reviews  47 Customer  1 Favorites | Vehicle serviced Recommended maintenance performed Battery replaced Four wheel alignment performed Vehicle washed/detailed Four tires balanced Four tires mounted Tire(s) mounted Steering/suspension checked Front brake rotor(s) replaced |
| 11/04/2009 | 72,953 | California Inspection Station San Jose, CA | Passed emissions inspection |
| 06/22/2011 | 77,327 | Beshoff Motorcars San Jose, CA 408-239-2300 | Vehicle serviced Maintenance inspection completed Electrical system checked Tire condition and pressure checked |
| 08/04/2011 | 78,801 | Mercedes-Benz of Stevens Creek San Jose, CA 408-641-4610  4.4 / 5.0 226 Verified Reviews  47 Customer  1 Favorites | Vehicle serviced Maintenance inspection completed Vehicle washed/detailed Tire condition and pressure checked Brake fluid flushed/changed Four tires balanced |
| 08/27/2011 | 79,473 | California Inspection Station San Jose, CA | Passed emissions inspection |
| 08/31/2011 | | Beshoff Motorcars San Jose, CA 408-239-2300 | Vehicle serviced Safety inspection performed Vehicle washed/detailed Body electrical system checked Wiper(s) replaced Emissions inspection performed |
| 08/31/2011 | | Dealer Inventory | Vehicle offered for sale |

| 09/12/2011 | 79,475 | Beshoff Motorcars San Jose, CA 408-239-2300 | Vehicle serviced |
|---|--------------------------------------|--|---|
| 09/14/2011 | | Mercedes-Benz of San Jose San Jose, CA 408-214-3009 ★ 4.2 / 5.0 122 Verified Reviews ❤️ 19 Customer Favorites | Vehicle sold |
| 09/19/2011 | | California Motor Vehicle Dept. San Jose, CA | Title issued or updated Loan or lien reported |
| 09/22/2011 | 79,833 | Beshoff Motorcars San Jose, CA 408-239-2300 | Vehicle serviced Vehicle washed/detailed Electrical system checked |
|  | Owner 3 Purchased: 2011 |  | Low mileage! This owner drove less than the industry average of 15,000 miles per year. |
| | | | Personal Vehicle 5,148 mi/yr |
| Date | Mileage | Source | Comments |

| | | | | |
|------------|---------|---|---|--|
| 10/14/2011 | | California Motor Vehicle Dept. Davis, CA | | Title issued or updated New owner reported Loan or lien reported |
| 11/01/2013 | 104,325 | California Inspection Station Davis, CA | | Passed emissions inspection |
| 08/05/2014 | | California Motor Vehicle Dept. Woodland, CA | | Registration updated when owner moved the vehicle to a new location |
| 10/29/2015 | 115,570 | California Inspection Station | | Passed emissions inspection |
| 11/12/2015 | | California Motor Vehicle Dept. Woodland, CA | | Title issued or updated Loan or lien reported |
| 06/08/2016 | 117,943 | Hoblit Dodge Chrysler Jeep hoblitdodge.com Woodland, CA 530-662-4667 530-662-4667 ★ 4.7 / 5.0 73 Verified Reviews ❤️ 11 Customer 5 Favorites |  | Vehicle serviced Maintenance inspection completed Oil and filter changed Tire condition and pressure checked |
| 06/08/2016 | | California Motor Vehicle Dept. Woodland, CA | | Title issued or updated |
| 05/03/2017 | 121,978 | Hoblit Dodge Chrysler Jeep hoblitdodge.com Woodland, CA 530-662-4667 530-662-4667 ★ 4.7 / 5.0 73 Verified Reviews ❤️ 11 Customer 5 Favorites |  | Vehicle serviced Brake fluid flushed/changed |
| 10/09/2017 | 124,660 | California Inspection Station | | Passed emissions inspection |
| 11/13/2017 | 125,102 | Hoblit Dodge Chrysler Jeep Woodland, CA 530-662-4667 ★ 4.7 / 5.0 73 Verified Reviews | | Vehicle offered for sale |

♥ 11 Customer
5 Favorites

11/15/2017 125,119 California
Inspection Station

Passed emissions inspection

11/30/2017
Hoblit Dodge Chrysler
Jeep
hoblitdodge.com
Woodland, CA
530-662-4667
530-662-4667

Vehicle serviced
Pre-delivery inspection completed
Vehicle washed/detailed
Oil and filter changed
Electrical system checked
Emissions inspection performed

★ 4.7 / 5.0
73 Verified Reviews
♥ 11 Customer
5 Favorites



Looks like this dealer serviced the car in order to prepare it for sale. That's a good thing!



👤 **Owner 4**
Purchased:
2017



Low mileage! This owner drove less than the industry average of 15,000 miles per year.

Personal Vehicle
6,361 mi/yr

| Date | Mileage | Source | Comments |
|------|---------|--------|----------|
|------|---------|--------|----------|

| | | | |
|------------|---------|---|--|
| 12/05/2017 | 125,158 | California Motor Vehicle Dept. Saint Helena, CA | Title issued or updated New owner reported Loan or lien reported |
| 12/28/2017 | 125,159 | Hoblit Dodge Chrysler Jeep hoblitdodge.com Woodland, CA 530-662-4667 530-662-4667 ★ 4.7 / 5.0 73 Verified Reviews ❤️ 11 Customer 5 Favorites |  Vehicle serviced |
| 01/10/2018 | | Damage Report |  Damage reported: minor damage |



Glossary



Damage Indicator

Damage can be a result of many different types of events. Examples include contact with objects (trees, traffic signs, road debris, etc), vandalism, or weather-related events. Not every damage event is reported to CARFAX. As details about the damage event become available, those additional details are added to the CARFAX Vehicle History Report. CARFAX recommends that you have this vehicle inspected by a qualified mechanic.

MINOR MODERATE SEVERE

- This CARFAX Vehicle History Report is based only on information supplied to CARFAX and is available as of 12/13/22 at 1:49:13 PM (CST). Other information about this vehicle, including problems, may not have been reported to CARFAX. Use this report as one important tool, along with a vehicle inspection and test drive, to make a better decision about your next used car.

Minor damage is usually cosmetic, including

10/30/2019 139,180 California

Inspection Station

Passed emissions inspection

Damage Severity

Damage events result in one of the following severity levels:

- Minor:** Generally, minor damage is cosmetic (including dents or scratches) and may only require reconditioning, and typically does not compromise a vehicle's operation and/or safety.
- Moderate:** Moderate damage may affect multiple components of the vehicle and may impair the vehicle's operation and/or safety.
- Severe:** Severe damage usually affects multiple components of the vehicle and is likely to compromise the vehicle's operation and/or safety.

 **Damage reported: minor damage**

Damage to front

Damage Severity Scale

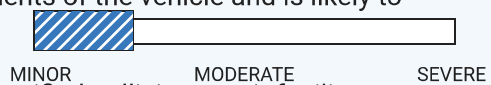

CARFAX recommends getting a professional inspection at a certified collision repair facility.

First Owner

When the first owner(s) obtains a title from a Department of

New Owner Reported

When a vehicle is sold to a new owner, the title must be transferred to the new owner. This information is reported to CARFAX for Motor Vehicles.

Ownership History

CARFAX defines an owner as an individual or business that purchases a vehicle. To provide estimates, CARFAX uses proprietary technology that analyzes all the events in a vehicle's history. Estimates are only available for vehicles manufactured after 1991 and titled in the US including ownership of a vehicle and are required to include the following st



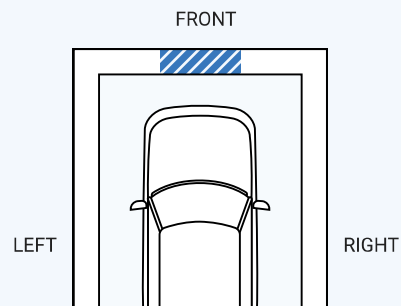



Damage Location



Oklahoma, Pennsylvania and South Dakota. Please consider this as you review a vehicle's estimated ownership history. **Owner 5** Personal Vehicle

Title Issued
2021

A state issues a title to provide a vehicle owner with proof of ownership. Each title has a unique number. Each title or registration record on a CARFAX report does not necessarily indicate a change in ownership. In Canada, a registration and bill of sale are used as proof of ownership.

| Date | Mileage | Source | Comments |
|------------|--|---|--|
| 01/14/2021 |  facebook.com/CARFAX  @CARFAXinc  | Title | Registration issued New owner reported Exempt from odometer reporting |
| 01/15/2021 | Oklahoma Motor Vehicle Dept. Oklahoma City, OK Title #810009469266 | California | Vehicle purchase reported Title issued or updated Loan or lien reported |
| 01/15/2021 | Saint Helena, CA Oklahoma | California | Title or registration issued |
| 09/29/2020 | 143,093 Motor Vehicle Dept. Dallas Auto Center Oklahoma City, OK Carrollton, TX Title #810009469266 | California | Exempt from odometer reporting Vehicle offered for sale |
| 04/16/2021 |  4.1 / 5.0 Modern Wheel Brake & Alignment 19 Customer Favorites Oklahoma City, OK 405-235-5385  5.0 / 5.0 8 Verified Reviews  7 Customer Favorites |  | Vehicle serviced |
| 07/16/2021 | Florida Motor Vehicle Dept. Palm Bay, FL Title #0143409267 | California | Title issued or updated Registration issued or renewed Titled or registered as personal vehicle Exempt from odometer reporting Registration updated when owner moved the vehicle to a new location Vehicle color noted as Silver |

Have Questions? Please visit our Help Center at www.carfax.com.